



// FEATURES

- Modular system
- Cross-draught extraction
- Suitable for ATEX zone 22 or zone 2.
- Range of standard sizes
- Two stage particle filtration up to H13

// CONSTRUCTION

- 2mm steel, fully welded
- Powder coated
- Easily reconfigured
- All components fully ATEX rated

// APPLICATIONS

- Designed for dust extraction

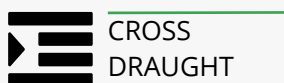

FEATURES



// MODULAR SYSTEM

The unique VertEx modular system allows for rapid build and rapid reconfiguration; or construction of large extracted walls in very short timescales.

// FILTER OPTIONS

Standard filters are independently ATEX rated for use in zone 22 and consist of a prefilter and F9 grade high efficiency final filter.

Optional H13 final filtration.



// HIGH POWER FANS

ATEX rated centrifugal fansets running from a standard 3ph supply provide high airflow at low power consumption.

// CONTROLS

Standard control options consist of a fully ATEX rated DOL starter to be mounted within the ATEX area, or a non-rated starter which can be mounted remotely.

Alternative control options are available.



// BUILD A BOOTH

From a simple extracted wall to a full height extracted booth, constructed within a day using the VertEx modular approach. VertEx Booth VB is fully compatible with VX ATEX rated units.

DIMENSIONS

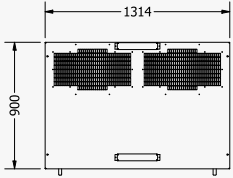

VX120618

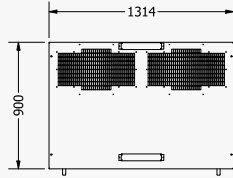

VX120624

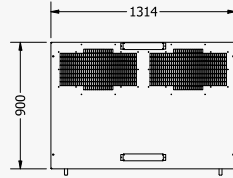

VX121224

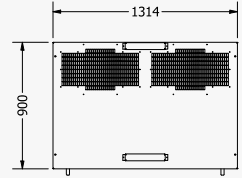

VX121831

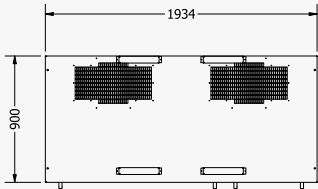
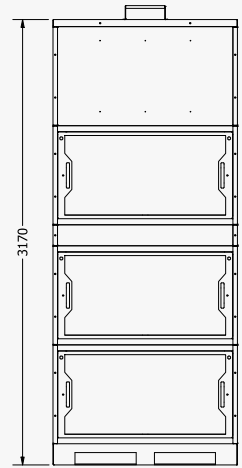
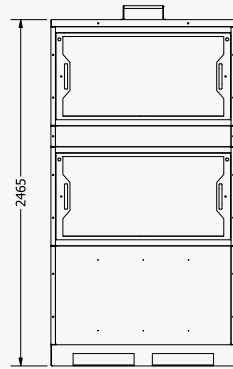
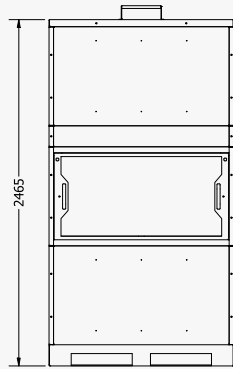
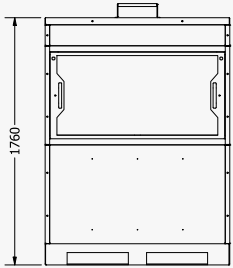

VX180618

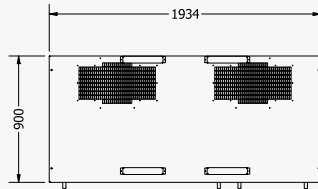

VX180624

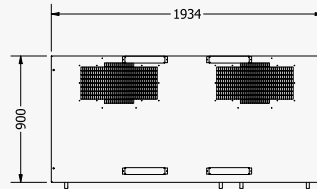

VX181224

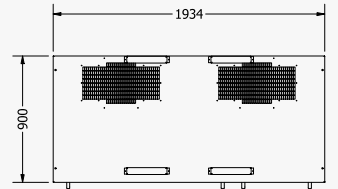

VX181831

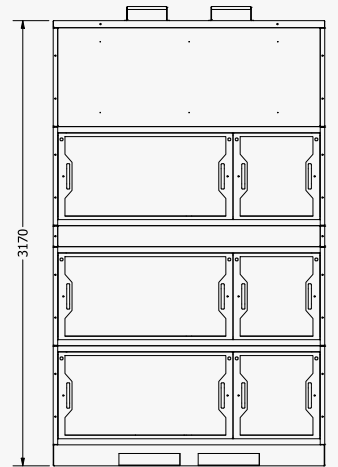
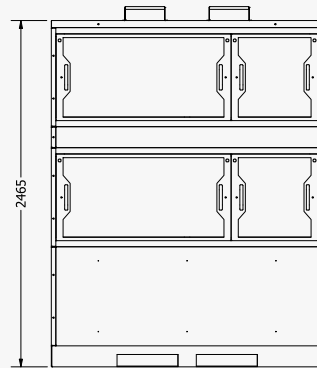
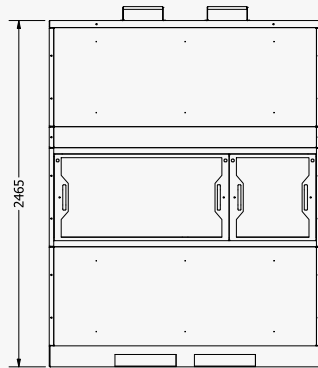
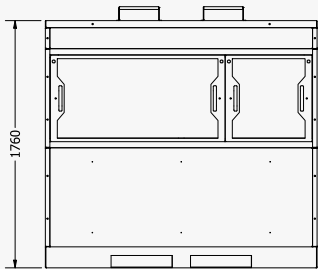

SPECIFICATIONS

// TECHNICAL DATA

MODEL	OVERALL			VENTILATED AREA		POWER kw	VOLUME @100Pa
	WIDTH	HEIGHT	DEPTH	WIDTH	HEIGHT		
VX120618Y	1314	1760	900	1200	600	1.1	2500
VX120624Y	1314	2465	900	1200	600	1.1	2500
VX121224Y	1314	2465	900	1200	1200	2.2	5100
VX121831Y	1314	3170	900	1200	1800	2.2	5100
VX180618Y	1934	1760	900	1800	600	2.2	5100
VX180624Y	1934	2465	900	1800	600	2.2	5100
VX181224Y	1934	2465	900	1800	1200	2.2	10200
VX181831Y	1934	3170	900	1800	1800	4.4	15300

// FILTER OPTIONS

FILTER CLASSIFICATION	FILTERS		FILTER CLASSIFICATION	FILTERS	
	PRE	FINAL		PRE	FINAL
X Fine Dust - ATEX	G4	F9	Y Fine Dust - ATEX H13	G4	H13

// GENERAL

POWER SUPPLY	415v/3ph	MOTOR	ATEX Rated - Forward Curved
NOISE LEVEL	<80dBA at 1m	FINISH	Textured grey powder coat
CONTROL	Optional ATEX rated DOL starter / control panel		

// SEE ALSO

VertEx VA - Modular Cross-Draught

VertEx Booth - Modular Booth

VertEx VP - Pulse Cleaned Filter System